

KLAUDIUS TYP 9

Art.-Nr.

397 088

	1300
	760
	1200
	mm

1/8

VO

28-2024

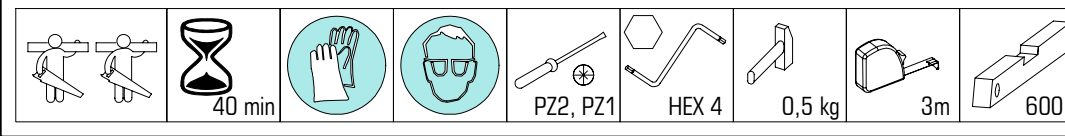

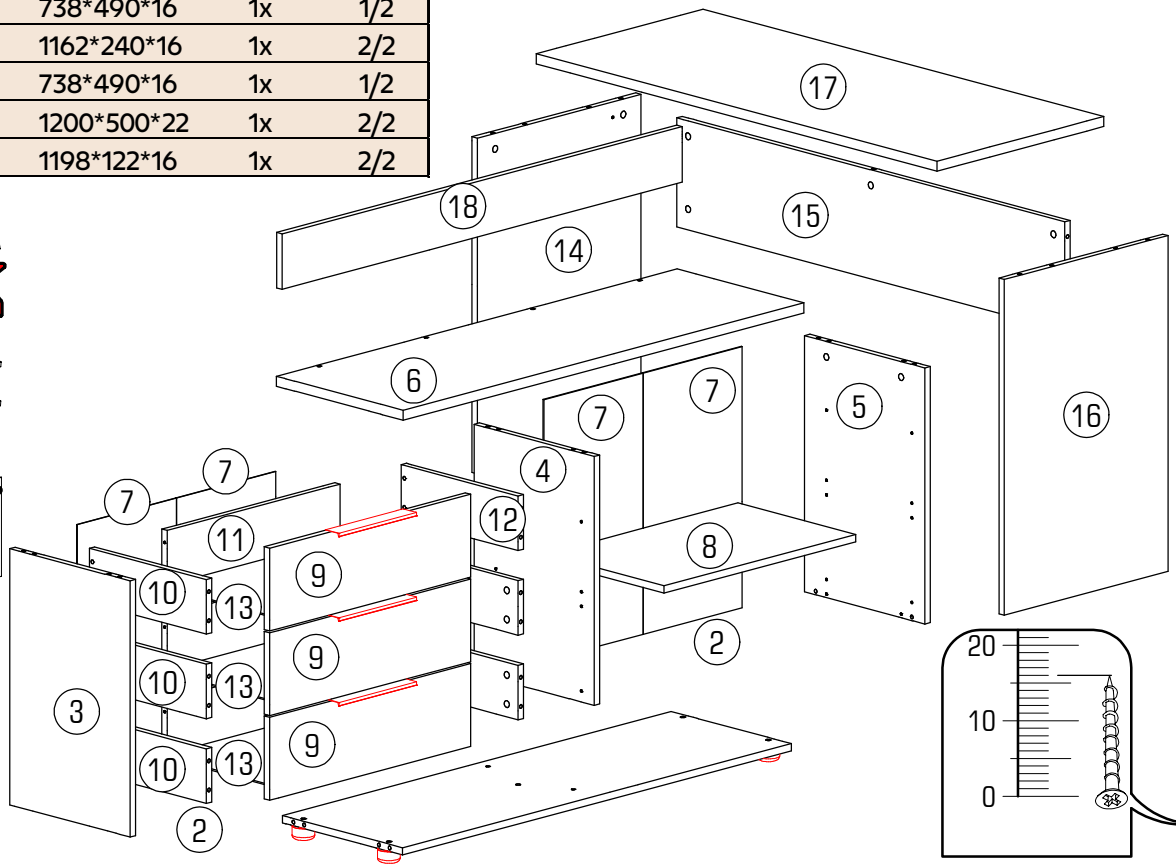
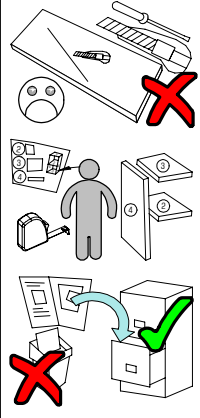
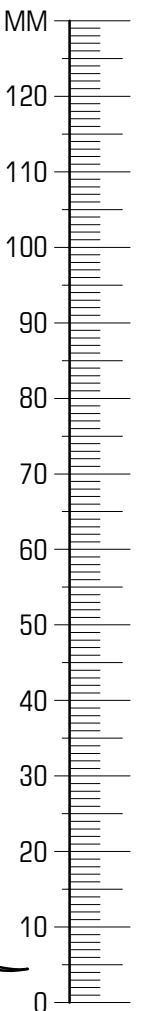
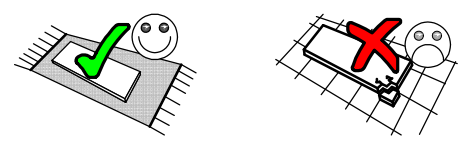
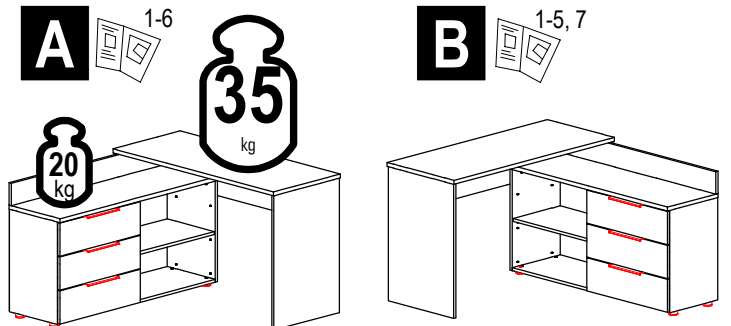

ID	ID			
21524	②	1164*360*16	1x	2/2
21525	③	563*360*16	1x	1/2
21526	④	547*360*16	1x	1/2
21527	⑤	563*360*16	1x	1/2
21528	⑥	1200*380*22	1x	2/2
21529	⑦	297*574*3	4x	1/2
21507	⑧	574*353*16	1x	1/2
21530	⑨	602*182*16	3x	1/2
19025	⑩	350*120*16	3x	2/2
21509	⑪	518*120*16	3x	1/2 2/2
19027	⑫	350*120*16	3x	2/2
21510	⑬	548*356*3	3x	1/2
21531	⑭	738*490*16	1x	1/2
21512	⑮	1162*240*16	1x	2/2
21532	⑯	738*490*16	1x	1/2
21533	⑰	1200*500*22	1x	2/2
21534	⑱	1198*122*16	1x	2/2



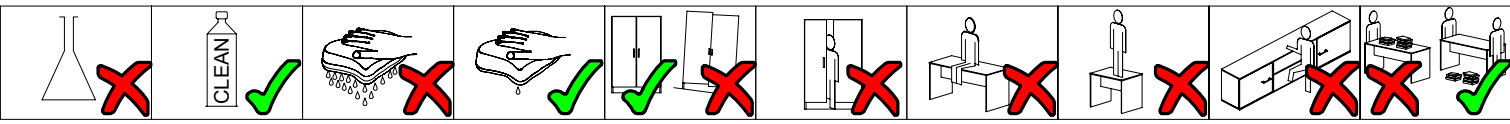

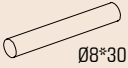
	8501.00		22244.01		30091.00		27000.00		70013.01		70021.01		22300.00		22705.00		22705.00	
A	4x	B	15x	C	4x	D	14x	E	11x	F	31x	G	31x	H	18x	J	12x	
	22243.00		22236.00		21102.00		33006.01		33006.01		22234.00		24008.00		32246.01		30082.01	
K	24x	L	16x	M	6x	N	50x	P	3x	Q	3x	R	6x	S	6x	T	3x	U

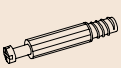

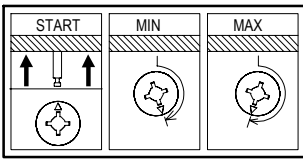
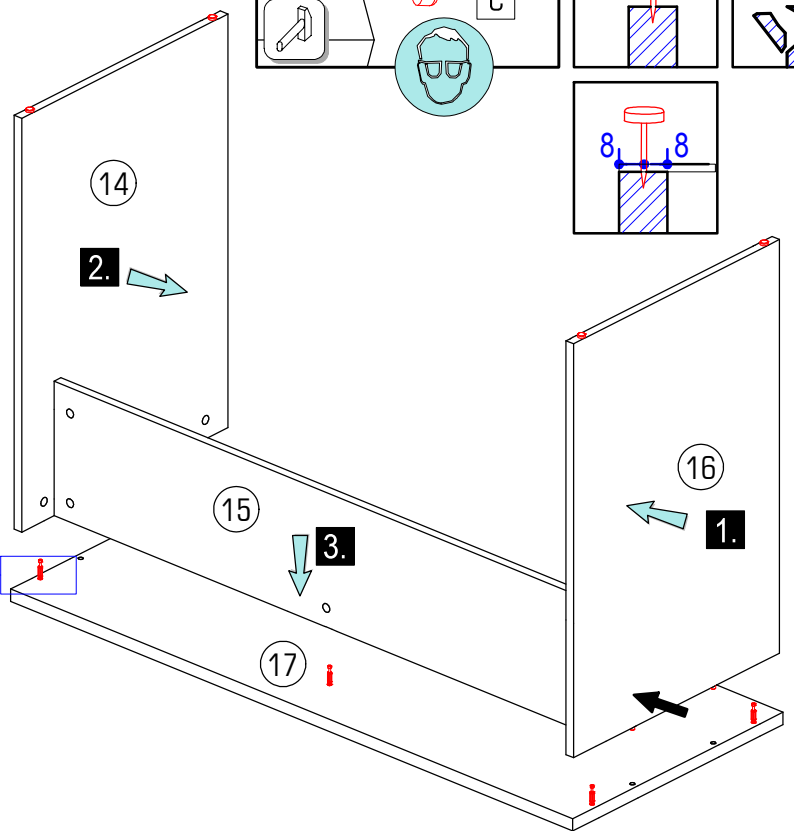
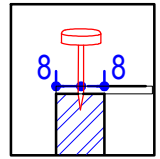
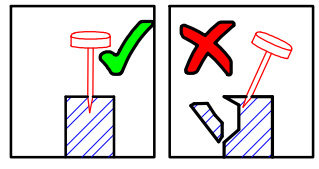
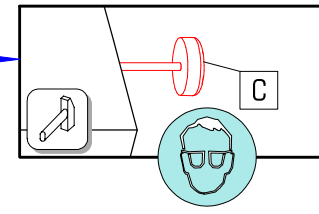
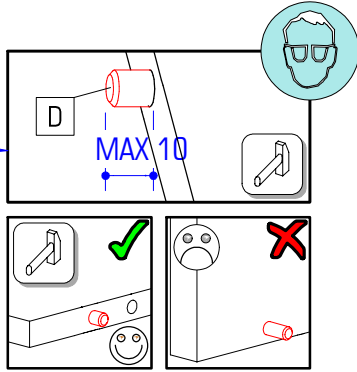
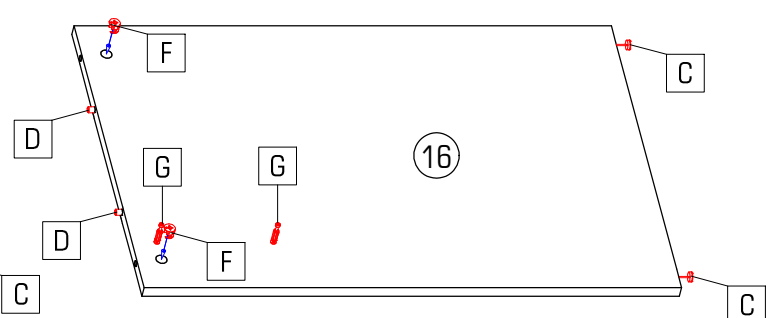
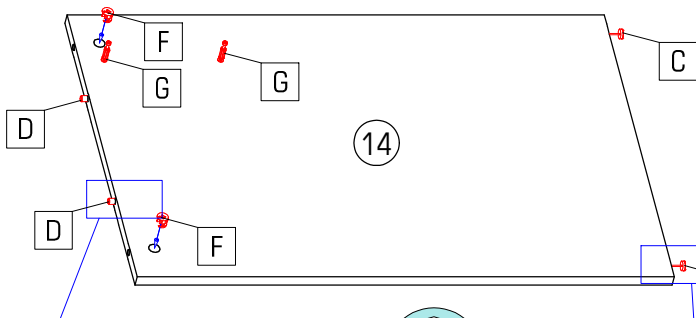
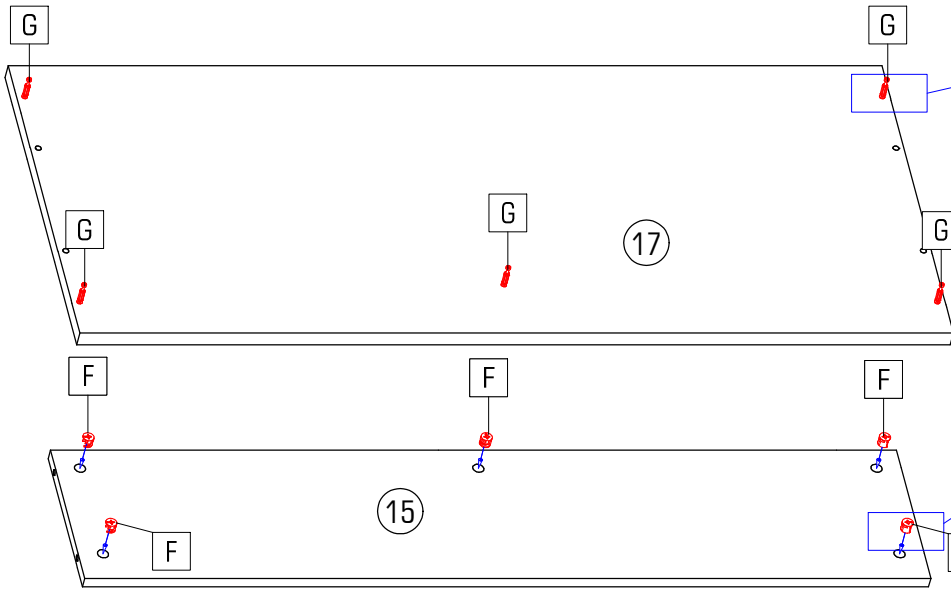
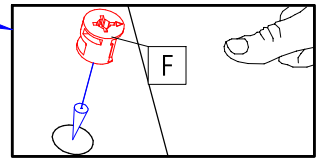
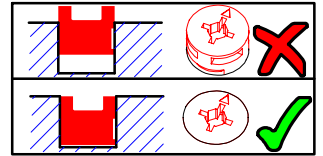
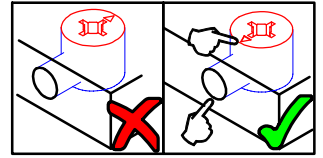
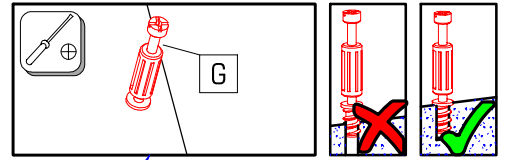
			
C	D	F	G
4x	4x	9x	9x



		
D	F	G
10x	10x	10x

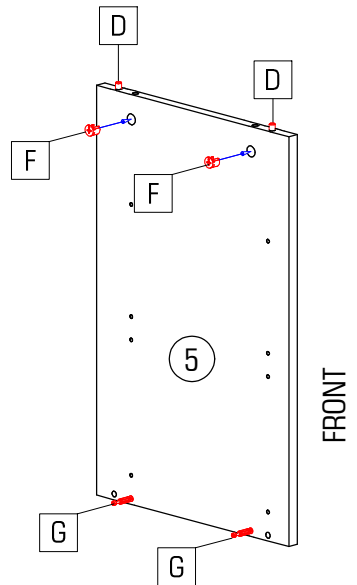
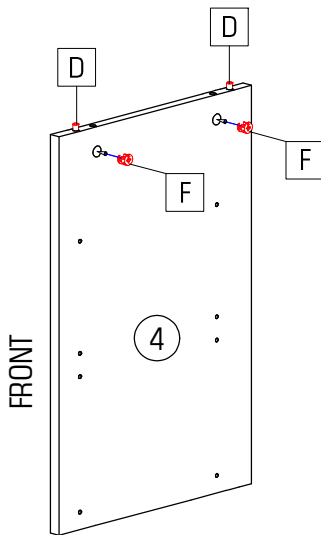
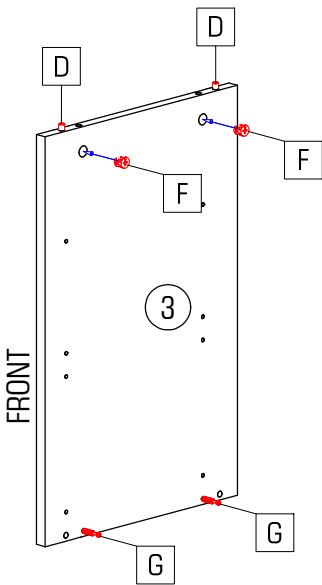
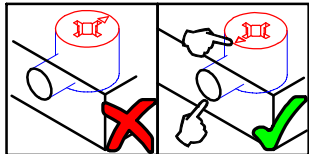
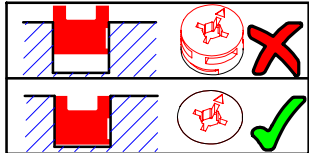
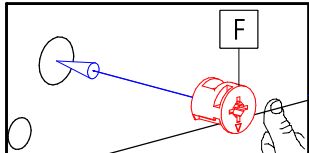
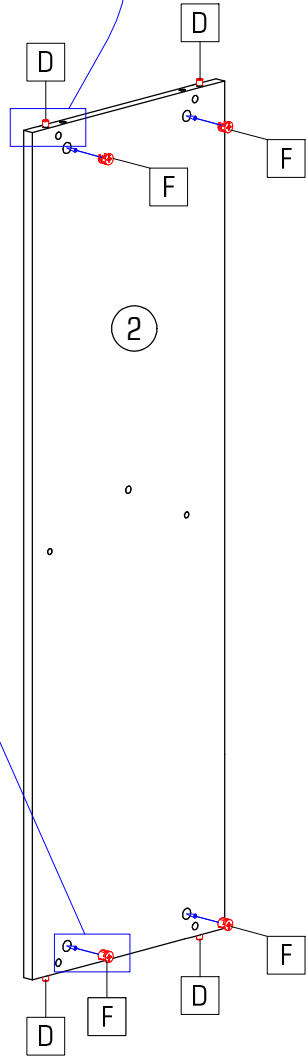
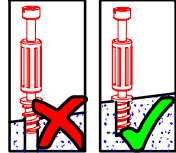
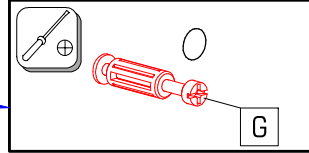
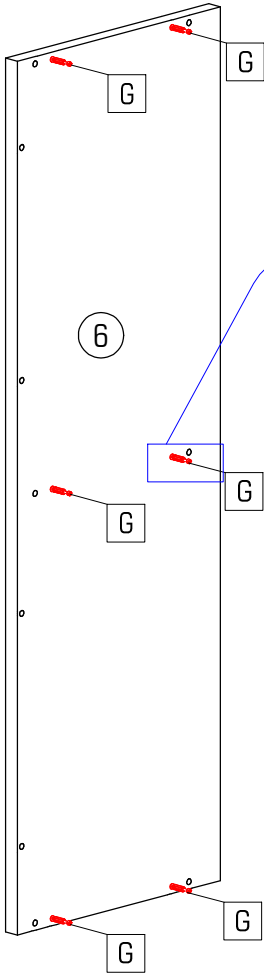
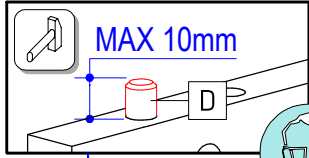
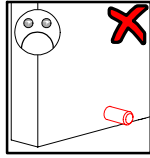
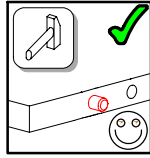

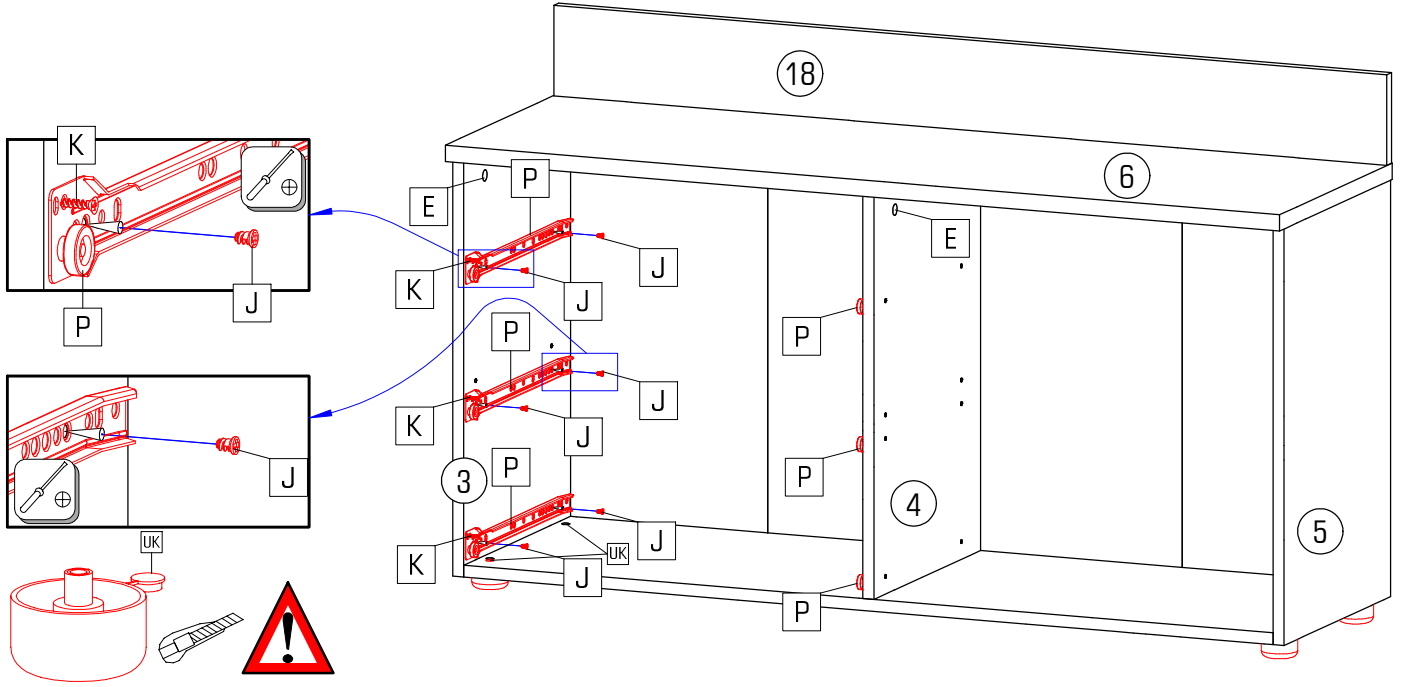

E	J	K	P
4x	12x	6x	3x
	Ø6,3x8	Ø3,5x15	L=350



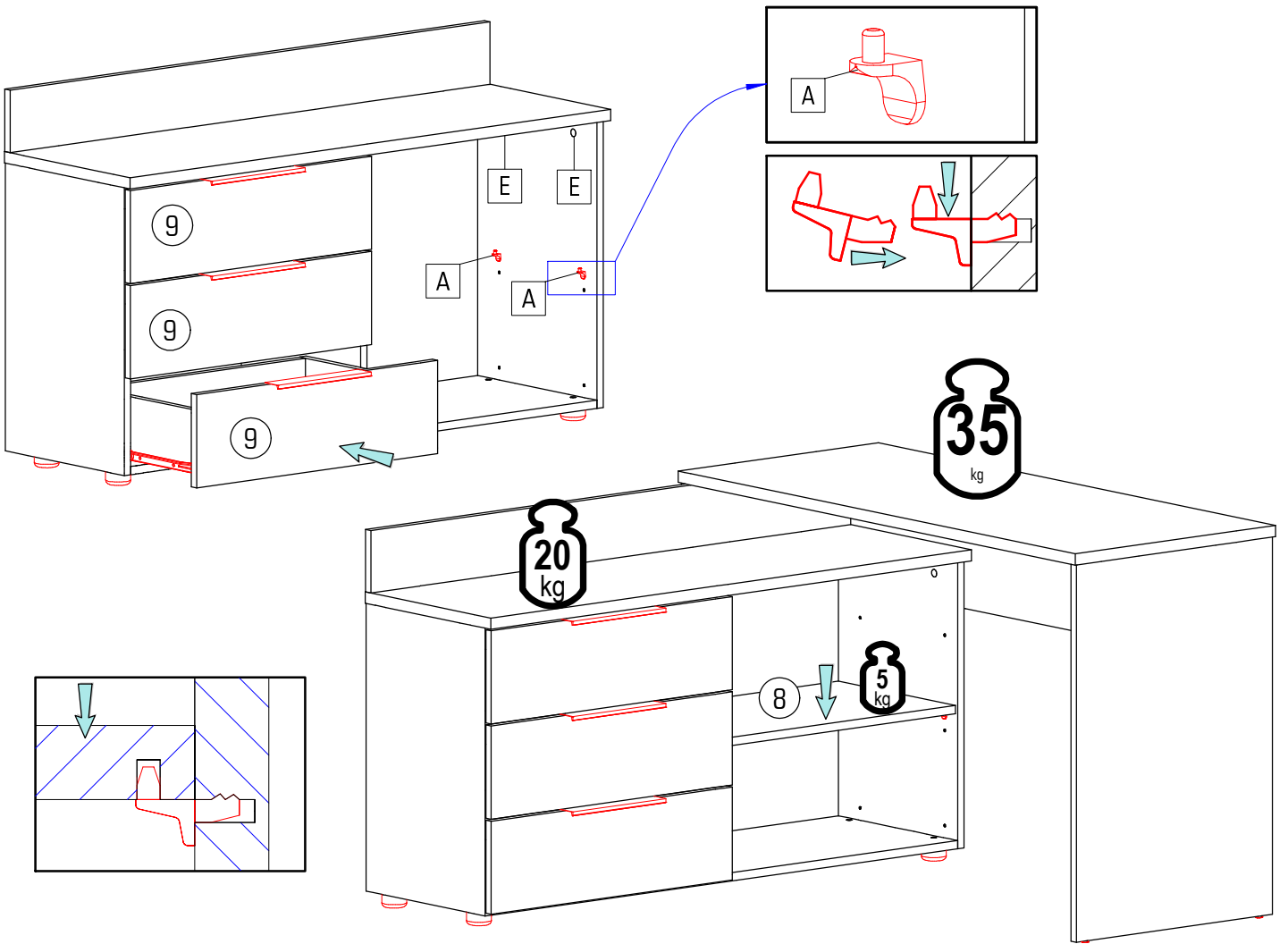

A	E	L
4x	7x	4x

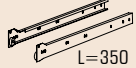

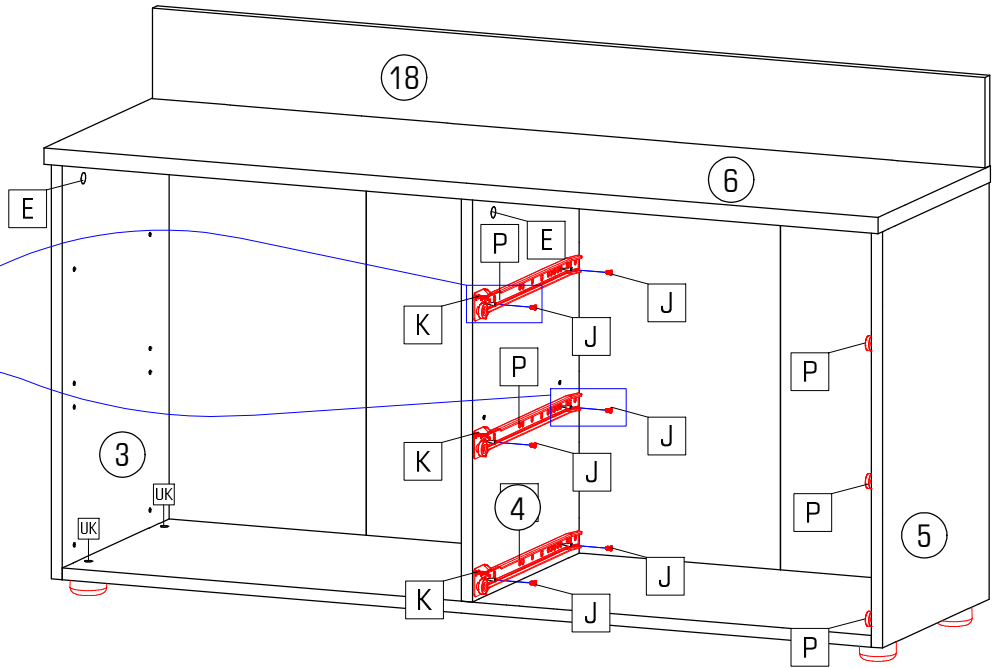
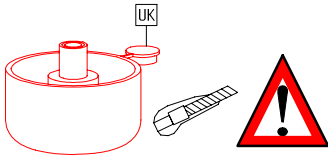
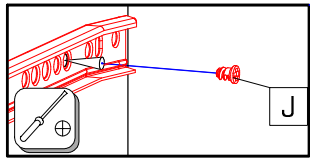
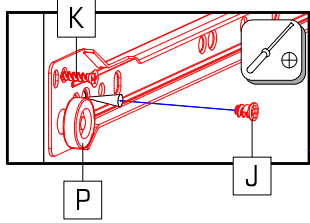
			
E 4x	J 12x	K 6x	P 3x



		
A 4x	E 7x	L 4x

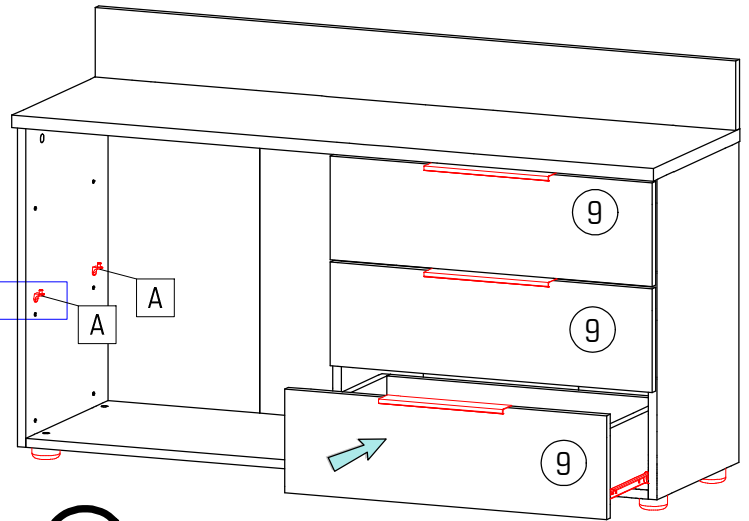
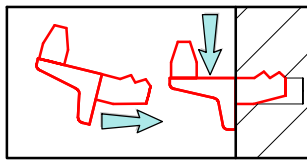
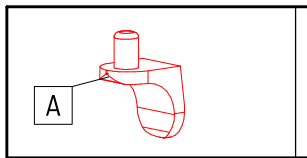

35
kg

20
kg

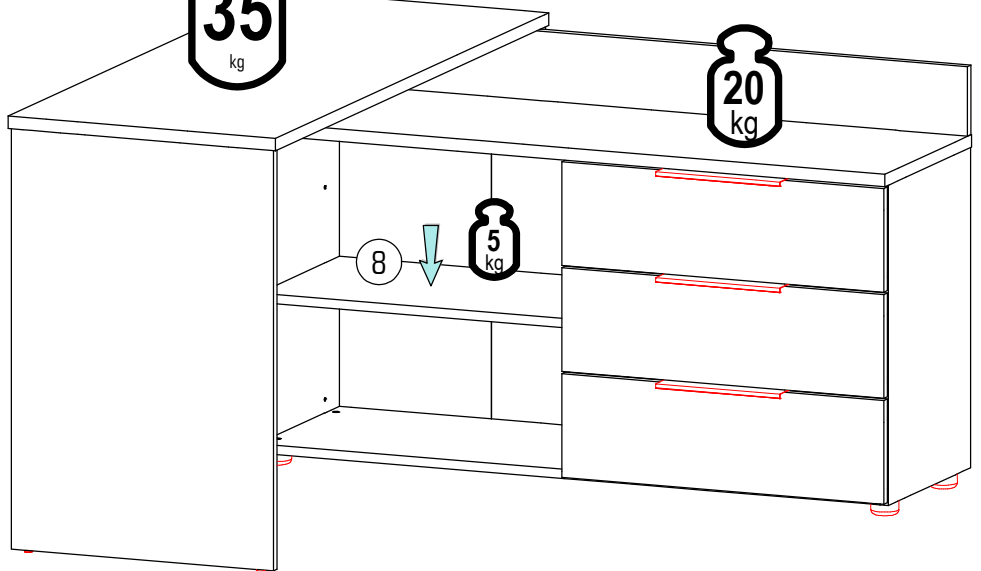
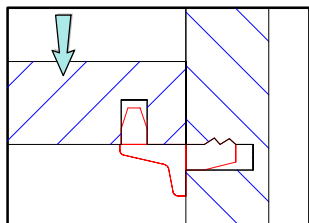

A

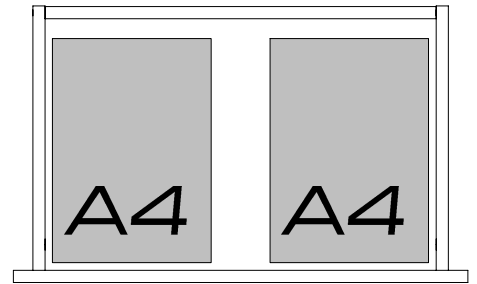
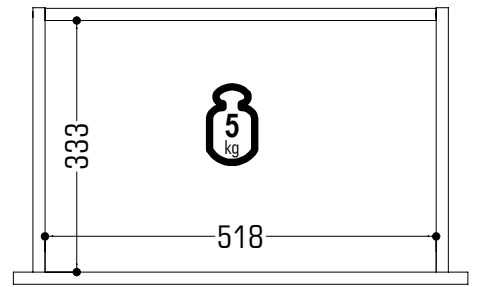
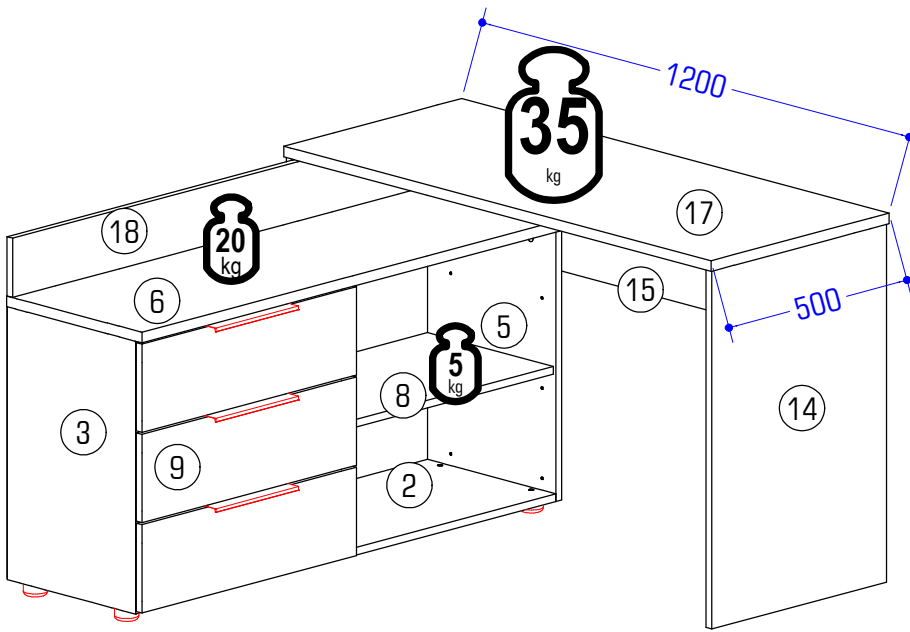

B

